

LYNX 36 IN. OUTDOOR VENT HOOD
 MODEL LOH36
 W/ DIMENSIONS

NOTE: THIS PRODUCT USES KNOCK-OUT PLATES WHICH LOCATE THE DUCT EXIT HOLE EITHER ON TOP OF THE HOOD OR AT THE REAR OF THE HOOD. THE ELECTRICAL ACCESS HOLE IS LOCATED ON THE TOP OF THE HOOD..

THE REAR DRAWING VIEW SHOWS REAR LOCATION. THE TOP VIEW SHOWS THIS HOLE IN THE TOP LOCATION.

TOP VIEW
 (DUCT EXIT SHOWN IN TOP LOCATION)

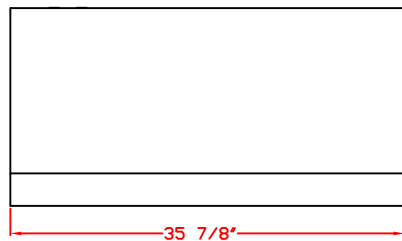
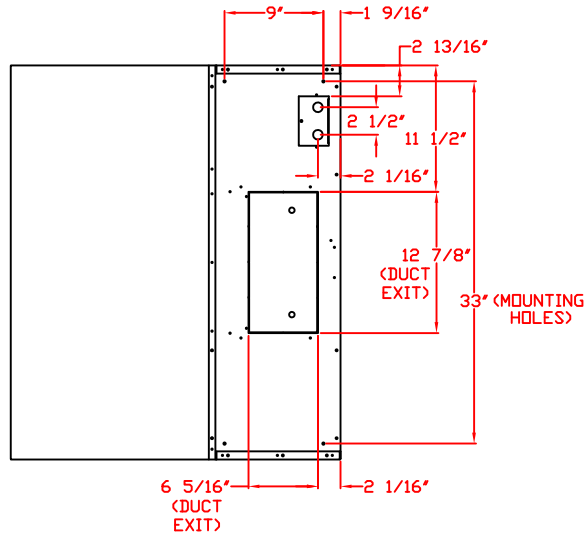

FRONT VIEW

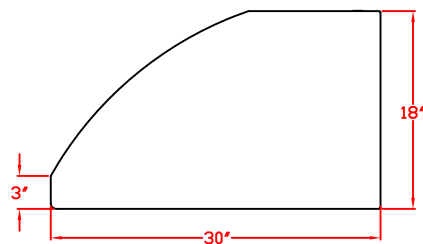

SIDE VIEW

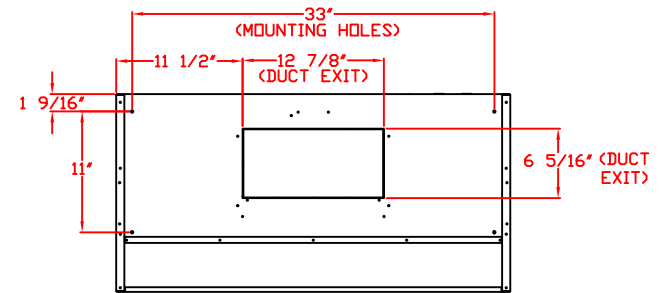

REAR VIEW
 (DUCT EXIT SHOWN IN BACK LOCATION)